

FLUKE®

Fluke 19xC-2x5C

ScopeMeter

Software version 8.00 onwards

Getting Started

GB
Jun 2008, Rev. 1, 09/2009
© 2008, 2009 Fluke Corporation, All rights reserved. Printed in the Netherlands
All product names are trademarks of their respective companies.

SCOPE

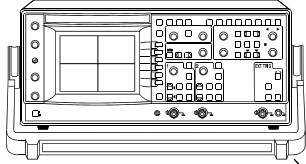

CURSOR

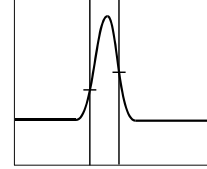

METER

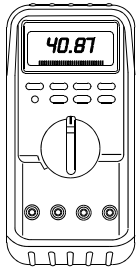

ZOOM

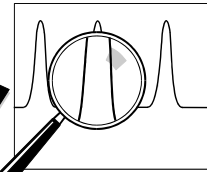

RECORDER

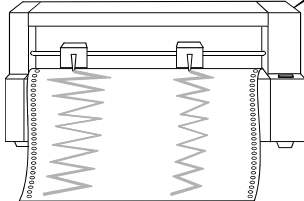

REPLAY

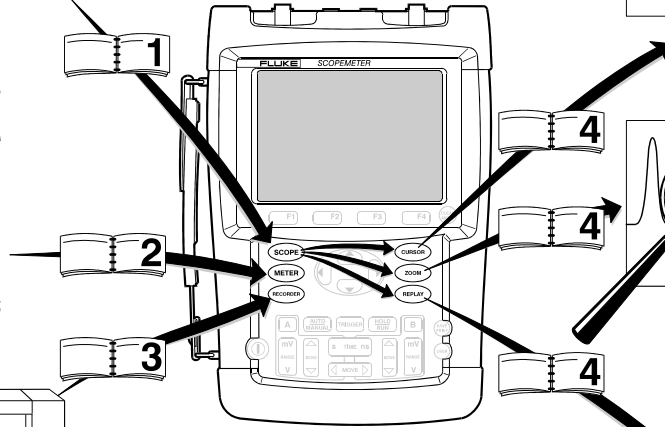
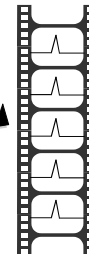

Table of Contents

Title	Page
Unpacking the Test Tool Kit	ii
Introduction	1
Contacting Fluke	1
Safety Information: Read First.....	1
Preparing for Use	4
Powering/Resetting the Test Tool	4
How to Navigate a Menu (example)	4
Changing the Information Language	5
Adjusting Contrast and Brightness	5
Using the Scope	5
Multimeter	7
Recorder Functions	8
Fieldbus Measurements (Bushealth).....	8
Replay	10
Zoom	10
Making Cursor Measurements	11
Triggering	11
Saving/Printing Screens and Setups	13
User Options	20

Unpacking the Test Tool Kit

The following items are included in your test tool kit:

1. ScopeMeter Test Tool
2. Battery Charger
3. 10:1 Voltage Probe Set (Red)
4. 10:1 Voltage Probe Set (Gray)
5. Test Lead Set (Red and Black)
6. Bus Health Test adapter (2x5C only)
7. Safety Information + CD ROM with complete Users Manual
8. Shipment box (basic version only)

The -S versions also include:

9. Optically Isolated USB Adapter/Cable
10. CD ROM with FlukeView[®] Software
11. Hard Case

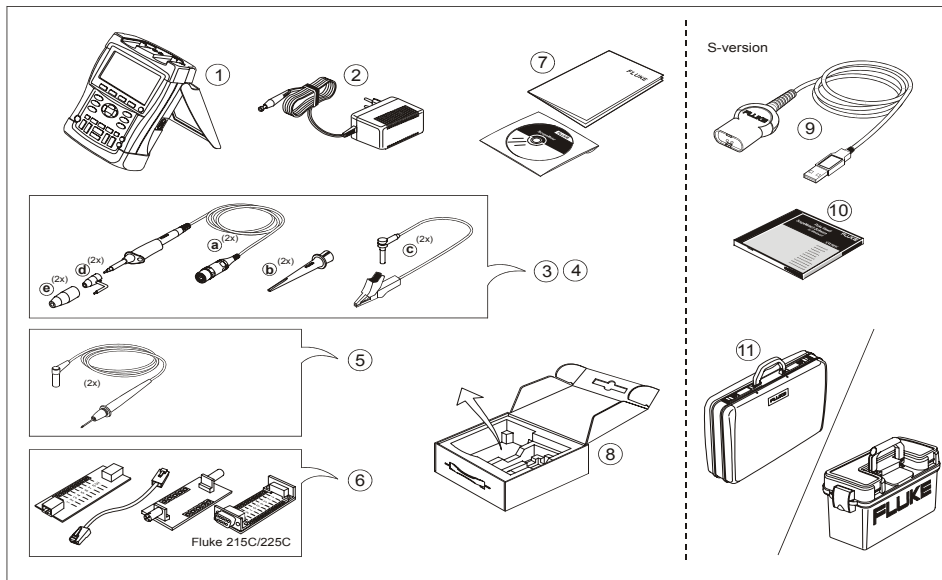

Figure 1. ScopeMeter Test Tool Kit

Getting Started

Introduction

This Getting Started Manual provides basic information on Models 192C, 196C, 199C, 215C and 225C, software versions V08.00 and newer. Refer to the *Users Manual* on the accompanying CD-ROM for complete operating instructions.

Contacting Fluke

To locate an authorized service center, visit us on the World Wide Web at: www.fluke.com or call Fluke using any of the phone numbers listed below:

+1-888-993-5853 in the U.S.A and Canada
+31-40-2675200 in Europe
+1-425-446-5500 from other countries.

Safety Information: Read First

The Fluke Models 192C, 196C, 199C, 215C and 225C ScopeMeter test tools (hereafter referred to as “test tool”) comply with:

- ANSI/ISA S82.01-1994
- EN/IEC61010-1 : 2001
- CAN/CSA-C22.2 No.61010-1-04
- 1000 V Measurement Category II, 600 V Measurement Category III, Pollution Degree 2
- UL61010B-1

Use the test tool only as specified in the *Users Manual*. Otherwise, the protection provided by the test tool might be impaired.

A **Warning** identifies conditions and actions that pose hazard(s) to the user. A **Caution** identifies conditions and actions that may damage the test tool.

⚠ Warning

To avoid electrical shock or fire:

- Use only the Fluke power supply, Model BC190 (Battery Charger / Power Adapter).
- Before use check that the selected/indicated voltage range on the BC190 matches the local line power voltage and frequency.
- For the BC190/808 universal Battery Charger/Power Adapter use only line cords that comply with the local safety regulations.

Note

To accommodate connection to various line power sockets, the BC190/808 universal Battery Charger / Power Adapter is equipped with a male plug that must be connected to a line cord appropriate for local use. Since the adapter is isolated, the line cord does not need to be equipped with a terminal for connection to protective ground. Since line cords with a protective grounding terminal are more commonly available you might consider using these anyhow.

⚠ Warning

To avoid electrical shock or fire if a test tool input is connected to more than 42 V peak (30 Vrms) or on circuits of more than 4800 VA:

- Use only insulated voltage probes, test leads and adapters supplied with the test tool, or indicated by Fluke as suitable for the Fluke 19xC-2x5C ScopeMeter series.
- Before use, inspect voltage probes, test leads and accessories for mechanical damage and replace when damaged.
- Remove all probes, test leads and accessories that are not in use.
- Always connect the battery charger first to the ac outlet before connecting it to the test tool.
- Do not connect the ground spring (Figure 1, item f) to voltages higher than 42 V peak (30 Vrms) from earth ground.
- Do not apply input voltages above the rating of the instrument. Use caution when using 1:1 test leads because the probe tip voltage will be directly transmitted to the test tool.
- Do not use exposed metal BNC or banana plug connectors.

- **Do not insert metal objects into connectors.**
- **Always use the test tool only in the manner specified.**

 **Max. Input Voltages**

Input A and B directly	300 V CAT III
Input A and B via 10:1 probe	1000 V CAT II 600 V CAT III
METER/EXT TRIG inputs	1000 V CAT II 600 V CAT III

 **Max. Floating Voltage**

From any terminal to earth ground	1000 V CAT II 600 V CAT III
Between any terminal	1000 V CAT II 600 V CAT III

Voltage ratings are given as “working voltage”. They should be read as Vac-rms (50-60 Hz) for AC sinewave applications and as Vdc for DC applications.

Measurement Category III refers to distribution level and fixed installation circuits inside a building.
Measurement Category II refers to local level, which is applicable for appliances and portable equipment.

The terms ‘Isolated’ or ‘Electrically floating’ are used in this manual to indicate a measurement in which the test tool input BNC or banana jack is connected to a voltage different from earth ground.

The isolated input connectors have no exposed metal and are fully insulated to protect against electrical shock.

The red and gray BNC jacks, and the red and black 4-mm banana jacks can independently be connected to a voltage above earth ground for isolated (electrically floating) measurements and are rated up to 1000 Vrms CAT II and 600 Vrms CAT III above earth ground.

If Safety Features are Impaired

Use of the test tool in a manner not specified may impair the protection provided by the equipment.
Before use, inspect the test leads for mechanical damage and replace damaged test leads!

Whenever it is likely that safety has been impaired, the test tool must be turned off and disconnected from the line power. The matter should then be referred to qualified personnel. Safety is likely to be impaired if, for example, the test tool fails to perform the intended measurements or shows visible damage.

Preparing for Use

At delivery, the installed NiMH batteries may be empty and must be charged for 4 hours (with the test tool turned off) to reach full charge:

- use only the Fluke Battery Charger/Power Adapter model BC190
- before use check that the BC190 voltage and frequency range match the local line power range
- connect the battery charger to the ac outlet
- connect the battery charger to the appropriate input on the test tool near Input B.

Caution

To prevent decrease of the battery capacity, you must charge the batteries at least once a year.

Powering/Resetting the Test Tool

Turning power on/off:



The test tool powers up in its last setup configuration.

Resetting the test tool to the factory settings:

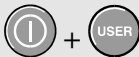

Turn power off, then press and hold the **USER** key and turn on. You should hear a double beep.

How to Navigate a Menu (example)



Display the input A function key labels.



Show the **Input A** (input A) menu.

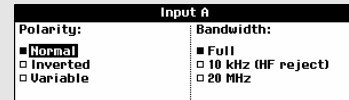

The menu example shows that the input A signal is displayed non-inverted (**Normal**) with full bandwidth (**Full**). To let input A invert the input signal, and to limit the bandwidth to 20 MHz do the following:



Highlight **Inverted** (inverted).



Accept **Inverted** + jump to the next field.



Highlight **20 MHz**.



Accept **20 MHz** + exit the menu.



Hiding a menu or key label:



Press the **CLEAR MENU** key.





Changing the Information Language

During operation of the test tool messages may appear on the screen (for instance if you select a recorder function). You can select the language in which messages will be displayed.

	Display the USER key labels.
	Open the LANGUAGE menu to select a language.

Options menu: OPTIONS... LANGUAGE VERSION & CAL... CONTRAST & LIGHT

Adjusting Contrast and Brightness

	Display the USER key labels.
	Enable the arrow keys for adjustment.
	Adjust the contrast of the screen.
	Change the backlight brightness.

Options menu: OPTIONS... LANGUAGE VERSION & CAL... CONTRAST & LIGHT

Using the Scope

Connect the probe(s) as shown in figure 2.

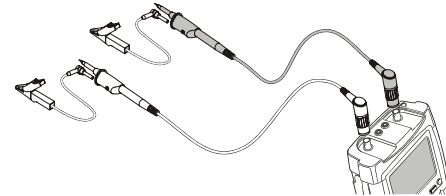



Figure 2. Scope Connections

AUTO- MANUAL ranging

After an Auto Set the trace position, range, time base and triggering will be automatically adjusted to assure a stable display of virtually any waveform.

	Perform an Auto Set or select Manual ranging (toggle). AUTO or MANUAL appears at the top right of the screen.
---	---

Use the light-gray **RANGE**, **TIME** and **MOVE** keys to change the view of the waveform manually.

Scope Readings and Waveforms

Automatic scope measurement results are shown as Reading 1 (**READING 1**) and Reading 2 (**READING 2**) at the upper left and right display edge.

The screenshot shows the main menu with 'SCOPE' selected. Below it, the 'F1' button is labeled 'Scope readings on (ON) or off (OFF)'. The 'F2' button is labeled 'Reading 1' and the 'F3' button is labeled 'Reading 2'. The 'Reading 1' configuration screen is shown with the following options:

Reading 1			
<input checked="" type="checkbox"/> on A	<input type="checkbox"/> Vac	<input type="checkbox"/> A ac...	<input type="checkbox"/> Hz
<input type="checkbox"/> on B	<input type="checkbox"/> Vdc	<input type="checkbox"/> A dc...	<input type="checkbox"/> Rise time
<input type="checkbox"/> Off	<input checked="" type="checkbox"/> U ac+dc	<input type="checkbox"/> A ac+dc...	<input type="checkbox"/> Fall time
	<input type="checkbox"/> Peak...	<input type="checkbox"/> Power...	<input type="checkbox"/> Pulse...
	<input type="checkbox"/> U pwm...	<input type="checkbox"/> Phase	<input type="checkbox"/> Duty...

Below the configuration screen, the following text is displayed:

- **on A** : Reading 1 (2) is input A result.
- **on B** : Reading 1 (2) is input B result.
- **V ac ...dB**: measurement function.

The screenshot shows the 'Waveform Options' menu with the following settings:

Waveform Options		
Glitch Detect:	Average:	Waveform:
<input checked="" type="checkbox"/> On	<input checked="" type="checkbox"/> Off	<input checked="" type="checkbox"/> Normal
<input type="checkbox"/> Off	<input type="checkbox"/> On...	<input type="checkbox"/> Persistence...
		<input type="checkbox"/> Mathematics...
		<input type="checkbox"/> Reference...

Below the menu, the following text is displayed:

- Glitch Detect:** glitch capture on or off.
- Average:** waveform averaging on or off.
- Waveform:**
 - **Normal** : normal waveform display.
 - **Persistence...** : waveform persistence.
 - Digital Persistence:** persistence off, short, medium, long, infinite.
 - Envelope:** envelope on, off.
 - Dot-join:** dot join on or off
 - **Mathematics...** : A+B, A-B, AxB, A vs B (XY mode), Spectrum (frequency spectrum FFT).
 - **Reference...** : compare waveforms, pass/fail testing.

Input A and Input B Settings

A	INPUT A On OFF	COUPLING DC AC	PROBE A 10:1...	INPUT A OPTIONS...
----------	-------------------	-------------------	--------------------	-----------------------

F1 Input A (B) on or off.

F2 Input coupling AC or DC.

F3

Probe on A		
Probe Type:	Attenuation:	
<input checked="" type="checkbox"/> Voltage	<input type="checkbox"/> 1:1	<input type="checkbox"/> 20:1
<input type="checkbox"/> Current	<input checked="" type="checkbox"/> 10:1	<input type="checkbox"/> 200:1
<input type="checkbox"/> Temp	<input type="checkbox"/> 100:1	<input type="checkbox"/> 1000:1
	<input type="checkbox"/> Probe Cal	

Probe Type: voltage, current or temperature probe.

Attenuation: probe attenuation.

Probe Cal...: calibration of 10:1 /100:1 probe.

F4

Input A	
Polarity:	Bandwidth:
<input checked="" type="checkbox"/> Normal	<input checked="" type="checkbox"/> Full
<input type="checkbox"/> Inverted	<input type="checkbox"/> 10 kHz (HF reject)
<input type="checkbox"/> Variable	<input type="checkbox"/> 20 MHz

Polarity: input polarity normal or inverted; variable input sensitivity.

Bandwidth: bandwidth full, 10 kHz, 20 MHz.

Multimeter

Connect the test leads (Figure 1, item 5) to the 4-mm safety banana jack METER input.

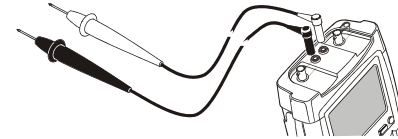

Figure 3. Meter connections

METER	MEASURE...	RELATIVE ON OFF	AUTO	MANUAL ↕
--------------	------------	--------------------	------	----------

F1 Select a measurement function.

Measurement		
Measure :		
<input checked="" type="checkbox"/> Ohms	<input type="checkbox"/> V ac	<input type="checkbox"/> A ac...
<input type="checkbox"/> Continuity®	<input type="checkbox"/> V dc	<input type="checkbox"/> A dc...
<input type="checkbox"/> Diode 🔍	<input type="checkbox"/> V ac+dc	<input type="checkbox"/> A ac+dc...
<input type="checkbox"/> Temp...		

F2 Relative measurements on or off.

F3 Automatic ranging.

F4 Manual ranging. Use to select a range.

Recorder Functions

First, choose a measurement in Scope or Meter mode.



Show the recorder functions. Select a recorder function (Scope Trendplot, Scope Record, or Meter Trendplot), then press **F4** to display the recorder key labels:

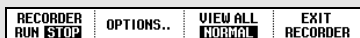

Start (**RUN**) or stop (**STOP**) recording.



Show the recorder options.

Reference: time reference is time of day (**Time of Day**) or time from start (**From Start**).

In Scope Record:

Display Glitches: glitch detection on, or 10 kHz filter on.

Mode: **Single Sweep** : stores samples until memory is full, then stops.

Mode: **Continuous** : stores samples continuously; deletes first samples if memory is full.

Mode: **on Ext. ...** : start (**Start**), stop (**Stop**) or continue (**Run**) recording if triggered via the meter input (**Ext.**). **Run** requires one trigger per division in **VIEW ALL** mode.

In Trend Plot:

Reading 1 (2)... (Scope) or **Measurement...** (Meter) show the measurement function menu.



VIEW ALL : see all stored samples.
NORMAL : see the most recent 9 divisions.



EXIT : exit the recorder mode.

Fieldbus Measurements (Bushealth)

The Bushealth function is standard available in the Fluke 215C-225C.

Selecting the Bus Type



Show the function selection screen. Select **Bushealth** , then press **F4** .



Highlight the required bus type, the press **F4** . Dots ... behind a bus type indicate that a submenu will follow on this selection.

The test tool shows the bushealth screen.



Show information on how to connect the test tool to the bus (**WIRING INFO**).







Show the bus signal eye pattern (waveform).

 Toggle between scope screen (OFF) and bushealth screen (ON).







Bushealth Screen

The following icons are used to indicate the bus measurement status:

Activity: ○○○○ bus activity indicators:	
1 ○○○○ ● (filled) : voltage measured	
	○ (open) : no voltage measured
○ ○ ² ○ ³ * * (blinking) : activity	
	○ ○ (both open) : no activity
 Busy, the tester is measuring/processing data.	
 No reading available.	
 Result OK .	
 Warning. Result on edge of limits	
 Result not OK.	

Setting up the Limits

To set up the test limits of the current bus type, do the following:

-  From the bushealth screen select **SETUP LIMITS...**
-  For RS-485 only: highlight **Manchester** or **NRZ** (default is **Manchester**). Press  to select the encoding type
-  Select the signal property for which you want to change the limits.
-  Select the limit you want to change, **LOW** (low limit), **HIGH** (high limit), **WARNING** (warn limit)
-  Change the limit. Continue with all limits to be changed.
-  Save the limits and return to the bushealth screen.

*Note: Changed limits are marked by a * (asterisk).*

Replay

In scope mode, the test tool automatically stores the 100 most recent screens. Use **REPLAY** to review these screens.

 From Scope mode show the **REPLAY** key labels.



 Step through the previous screen.

 Step through the next screens.

 Continuously play the stored screens.

 Exit the **REPLAY** mode.

Zoom

Use the zoom function to obtain a more detailed view of a waveform.

 Display the **ZOOM** key labels. Observe that the trace is frozen (**HOLD** appears at the top of the screen).





 Zoom in or zoom out on the waveform.

 Scroll. A position bar indicates the position of the zoomed part in relation to the total waveform.

 Inactive key. The key label indicates the zoom factor.

 **VIEW ALL** : view the complete waveform.
ZOOMED : view the zoomed waveform part.

 Inactive key.

 Exit the **ZOOM** mode.





Making Cursor Measurements

Cursors allow you to make precise digital measurements on live, on recorded, and on saved waveforms.

CURSOR Display the **CURSOR** key labels.





F1 Select cursor measurement type:

-  measure signal height at one point of time.
-  measure signal height difference of two points of time, and measure the time or the trace RMS value between the cursors.
-  measure signal height at the cursor positions and between cursor positions.
-  measure rise time and fall time.

F2 Select the cursor to be moved. Use the blue arrow keys to move.

F3 Depending on cursor measurement type:

-  Automatic or manual risetime measurement on a single channel.
-  Reading 2 is time (T), frequency (1/T), or RMS value.

F4 Cursor measurements on trace **A**, **B** or **M** if A and B are on; M if **Mathematics...** is on, see ScopeReadings and Waveforms on page 6. **OFF**: Switch cursor measurements off.

Triggering

Triggering tells the test tool when to begin displaying the waveform.

Automatic triggering assures a stable display of virtually any signal:

AUTO MAN Perform an auto set. AUTO appears at the top right of the screen. Input A is the default trigger source.

Now you can take over basic trigger controls such as source, level, slope and delay:

TRIGGER Display the trigger key labels



F1 **A B** : trigger on input A or B waveform
Ext : trigger on the meter-input signal.

F2 Select the trigger slope.

F3

Select trigger level control:

- at automatic triggering via input A or B (**AUTO TRIG**):



AUTO LEVEL : automatic level control.

MANUAL : manual level control.

- at triggering via the meter input (**Ext**):
0.12V 1.2V : select level 0.12V or 1.2V.

- at triggering on edges via input A or B (**EDGE TRIG**, see F4 below):

LEVEL : adjust the level manually.

Use   to adjust the trigger level.

F4

Select trigger options:

- **Automatic...** : automatic triggering on signals >1 Hz or > 15 Hz (faster).
- **On Edges...** : turns off automatic triggering and opens the **Trigger on Edge** menu:

Update: (screen update)

- Free Run** : the test tool updates the trace even if there are no triggers.
- On Trigger** : the screen is updated *only* when valid triggers occur.

- Single Shot** : the test tool waits for a trigger. After receiving a trigger, the waveform is displayed and the instrument is set to HOLD.

Press  to arm for a new trigger.

Noise reject Filter: the noise reject filter reduces jitter on the screen when triggering on noisy waveforms.

NCycle: Each Nth trigger results in a trace update.

- **Video on A...** : enables triggering on video signals (input A only).

Pulse Width on A... : enables triggering on qualified pulses (input A only).

Trigger Point, Trigger Delay

The trigger icon  shows the trigger point. Initially you have two divisions of pre-trigger view (negative delay). To change the trigger delay, do the following:



Hold down to adjust the trigger delay.

If you move the trigger icon to the left of the screen, it changes to . The status at the bottom of the screen shows for example: **AJ -+500.0ms**

The 500ms indicates the (positive) delay between the trigger point and the waveform display.

Saving/Printing Screens and Setups

You can save screens, recordings and setups to memory, and recall them again from memory. You can print actual or recalled screens.



Display the **SAVE PRINT** key labels.

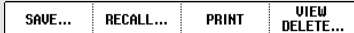

F1

SAVE: save a screen + setup (**Screen + Setup**), or a record/replay/trendplot + setup (**Record + Setup, Replay+Setup, TrendPlot+Setup**) in a memory location.

The **Edit Name** menu allows you to change the name for the saved item:

- press **F2** **F3** to select the character to be changed.
- press the arrow keys to select a character.
- press **F1** to set default name.
- press **F4** to save.

F2

RECALL : open the **Recall** (recall) menu.

RECALL FOR REFERENCE: recall a screen as a reference waveform.

RECALL SETUP: recall a setup. Test tool is in run mode.

RECALL: recall a screen + setup, or a record + setup. Test tool is in hold mode.

CANCEL: Close menu

F3

PRINT: Print the displayed screen. Refer to the User Options below for printer setup information.

F4

VIEW DELETE : open the **View/Delete** menu.

DELETE: clear the selected memory.

RENAME... : rename a saved item.

VIEW : view and/or print a saved item.

CANCEL: Close menu.

Note

When saving a screen the most recently acquired waveform will be stored. Persistence waveforms will not be stored.

User Options

Display the **USER** key labels.

OPTIONS... LANGUAGE VERSION & CAL... CONTRAST LIGHT

F1 Open the options menu.

User Options	
Auto Set Adjust...	Printer Setup...
Battery Save Options...	Factory Default
Battery Refresh	Display Options...
Date Adjust...	
Time Adjust...	

Auto Set Adjust...

Select how auto set (**AUTO** key) behaves:

- auto set on signals >15 Hz (fast response) or >1 Hz (slower response).
- set input coupling to DC (**Set to DC**) or don't change the input coupling setting.
- set glitch detection on (**Set to On**) or don't change the glitch detection setting.

Battery Save Options...

When powered on the battery only, the test tool initially shuts itself down 30 minutes after you pressed a key (not in Trend Plot or Scope Record).

You can set the automatic power shutdown time to 5 minutes and to 30 minutes, or you can disable the automatic power shutdown (**Disabled**).

Battery refresh

Start a battery refresh about four times a year to keep the batteries in optimal condition. The batteries will be fully discharged and charged again.

Date adjust...

Set the date (Year: Month: Day:) and the date format (DD/MM/YY is day- month-year, MM/DD/YY is month-day-year).

Time Adjust...

Set the time clock (Hours - Minutes - Seconds).

Printer Setup...

Select a printer type and select the baud rate.

Factory default

Clears all memories and sets the test tool to factory defaults.

Display Options...

Set the display to color (**Color**) or black and white (**Black and White**).